

Technical data sheet

Connection thread sealing ring, metric

Item number: 2030012

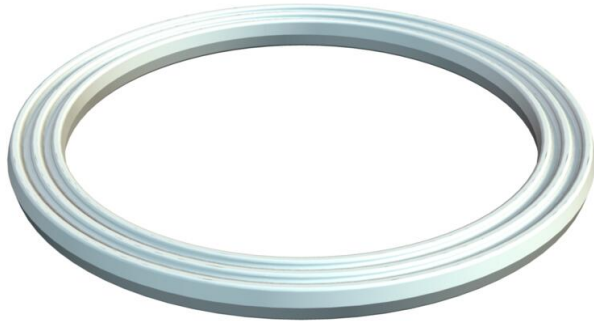

Connection thread sealing ring, suitable for all plastic cable glands, with metric thread according to DIN EN 60423 or ISO 68. The internal diameters of the sealing rings are designed in such a way that they can be pre-mounted in a captive manner.



PE Polyethylene

Master data

Item number	2030012
Type	107 F M20 PE
Description 1	Connection thread sealing ring
Manufacturer	OBO
Dimension	M20
Material	Polyethylene
Smallest sales unit	100
Unit of quantity	Piece
Weight	0.03 kg
Weight unit	kg/100 pc.
CO2 Footprint (GWP) Cradle-to-Gate	0,0099 kg CO2e / 1 Piece

Dimensions

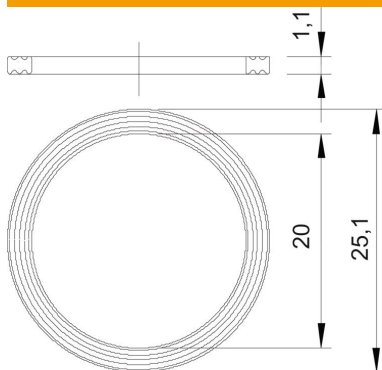

Dimension D1	25.1 mm
Dimension D2	20 mm
Dimension t	1.1 mm

Technical data sheet

Connection thread sealing ring, metric

Item number: 2030012



Technical data

Version for	Flat sealing ring
Suitable for metric thread dimension	20
Inner diameter	20 mm