

Technical data sheet

Connection thread sealing ring, metric

Item number: 2030024

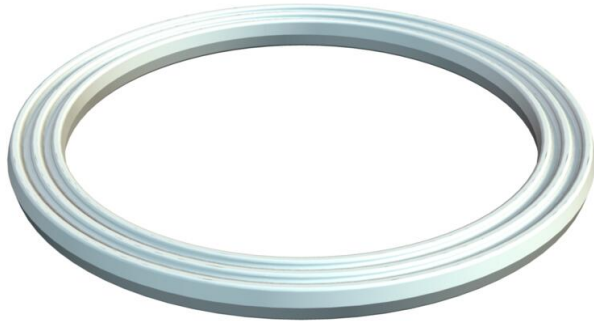

Connection thread sealing ring, suitable for all plastic cable glands, with metric thread according to DIN EN 60423 or ISO 68. The internal diameters of the sealing rings are designed in such a way that they can be pre-mounted in a captive manner.



PE Polyethylene

Master data

| | |
|------------------------------------|--------------------------------|
| Item number | 2030024 |
| Type | 107 F M40 PE |
| Description 1 | Connection thread sealing ring |
| Manufacturer | OBO |
| Dimension | M40 |
| Material | Polyethylene |
| Smallest sales unit | 100 |
| Unit of quantity | Piece |
| Weight | 0.2 kg |
| Weight unit | kg/100 pc. |
| CO2 Footprint (GWP) Cradle-to-Gate | 0,0052 kg CO2e / 1 Piece |

Dimensions

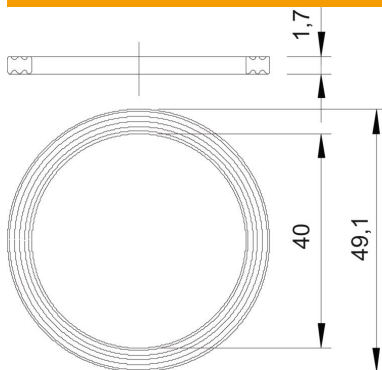

| | |
|--------------|---------|
| Dimension D1 | 49.1 mm |
| Dimension D2 | 40 mm |
| Dimension t | 1.7 mm |

Technical data sheet

Connection thread sealing ring, metric

Item number: 2030024



Technical data

| | |
|--------------------------------------|-------------------|
| Version for | Flat sealing ring |
| Suitable for metric thread dimension | 40 |
| Inner diameter | 40 mm |